

USER'S MANUAL



Serial Number: _____

Voltage: _____



Safety Issues

- When installing the D400, exercise due care at all times. The turbine weighs 17.2 kilograms and is awkward in shape. It is best to plan the installation carefully in advance and enlist some help when erecting the machine in order to avoid accidents.
- Complete as much of the installation procedure as possible at ground level.
- Choose a calm, dry day for your installation if possible.
- D400 blades are quite sharp, particularly on their trailing edges. Handle with care.
- D400 is robustly engineered, but contains high-energy ferrite magnets that can be damaged if the machine is dropped or handled heavily.
- When running, particularly if disconnected from the batteries, D400 is capable of producing high voltages. Caution must be exercised at all times to avoid electric shocks.
- Always observe correct polarity when connecting D400 to an electrical circuit. Reverse polarity connection will result in damage to the wind generator.
- The D400 must be appropriately fused at all times.
- Never approach the path of the blades when the machine is operating as severe personal injury could result.
- Always stop the machine and secure the blades before attempting maintenance.
- Ensure that all batteries are disconnected when undertaking maintenance.

PLEASE NOTE:

The D400 is designed to be permanently connected to a suitable electrical load such as a battery bank, dump regulator or inverter.

It should never be allowed to run unloaded, ie. open-circuit, for more than a few minutes.

In an open-circuit condition, the D400 will overspeed, and very high voltages can be produced.

There is also a risk of damage to the machine's rectifiers.

Contents

Safety issues	1
Introduction	2
Features of the D400	3
Dimensions	4
Output	4
Checklist (parts, tools etc)	5
Principles of wind energy	5
Installation - Boats	6
Terrestrial mounting	7
Guyed towers	7
Freestanding towers	8
Roof mounting	8
Assembling the D400	9/10
Electrical connections	11
Regulation	11
Stopping the D400 / Braking switch	12
Electrical installation/ Circuit diagrams	13/14
Performance and expectation	15
'Trouble-shooting'	16/18
Routine maintenance	19
CE Conformity	20
Guarantee	20
Appendix: Specifications	
Estimated Annual Generation	

Thank you for purchasing the D400 Wind Generator,
designed and manufactured by Eclectic Energy Limited.
The D400 is one of the most efficient, powerful and well-engineered
turbines currently available. Please read the entire manual
thoroughly prior to installation to ensure your personal safety and
the optimum performance of the equipment.
If you have any questions or uncertainties, having read the manual,
please contact your authorised dealer, or Eclectic
Energy Ltd, for further clarification.

Features of the D400

The D400 has been developed specifically to operate in close proximity to people. The noise and vibration usually associated with small wind turbines has been designed out of the D400. This has been achieved by making the turbine run relatively slowly for a given electrical output. In a given wind speed and a given electrical output, the D400 rotates at less than one quarter the speed of some competitor units. Combined with its rugged engineering and advanced computer-designed air blades, this makes the D400 the most reliable and benign turbine of its class currently available.

The air blades are precision injection-moulded from glass reinforced nylon and as well as featuring taper and twist incorporate a special low-Reynolds airfoil section which varies continually in camber from tip to root. Because of the production method used, the blades are extremely consistent in terms of mass and can be replaced singly should damage occur without losing turbine balance. The alternator and yaw shafts are precision-ground from 316 grade stainless steel, and the D400's body is a robust aluminium alloy casting.

The bearings are high quality and generously sized, and are protected by twin-lipped radial shaft seals.

The tail is formed from aluminium sheet into a shallow 'S' section in order to impart stiffness and prevent resonance. All aluminium parts are etched, alachromed and finished in a tough polyester powder coat.

The D400 utilises a 12-pole, 3-phase axial field alternator of very high efficiency. It comprises two large annular magnet rotors with stator coils positioned in between. The stator coils themselves are wound from heavy gauge copper and are encapsulated in a heat-conductive resin. This in turn is bolted to a machined shelf within the aluminium housing, so ensuring excellent heat dissipation from the machine. A combination of the advanced air blade and alternator design delivers unparalleled efficiency in low wind speeds together with the ability to produce sustained high outputs in high winds.

Eclectic Energy Ltd's attention to design and quality should ensure your D400 gives years of trouble-free service.

Congratulations on your purchase.



Dimensions, output

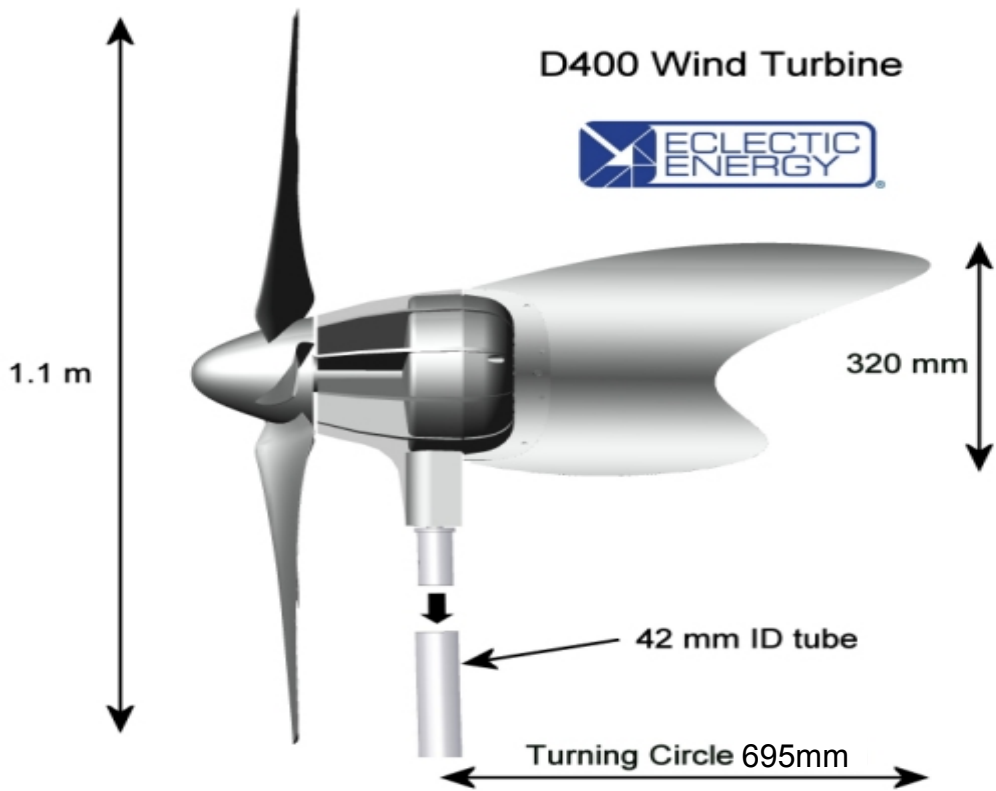

Rated outputs 225 watts at 11 m/s, 400 watts at 16.5 m/s

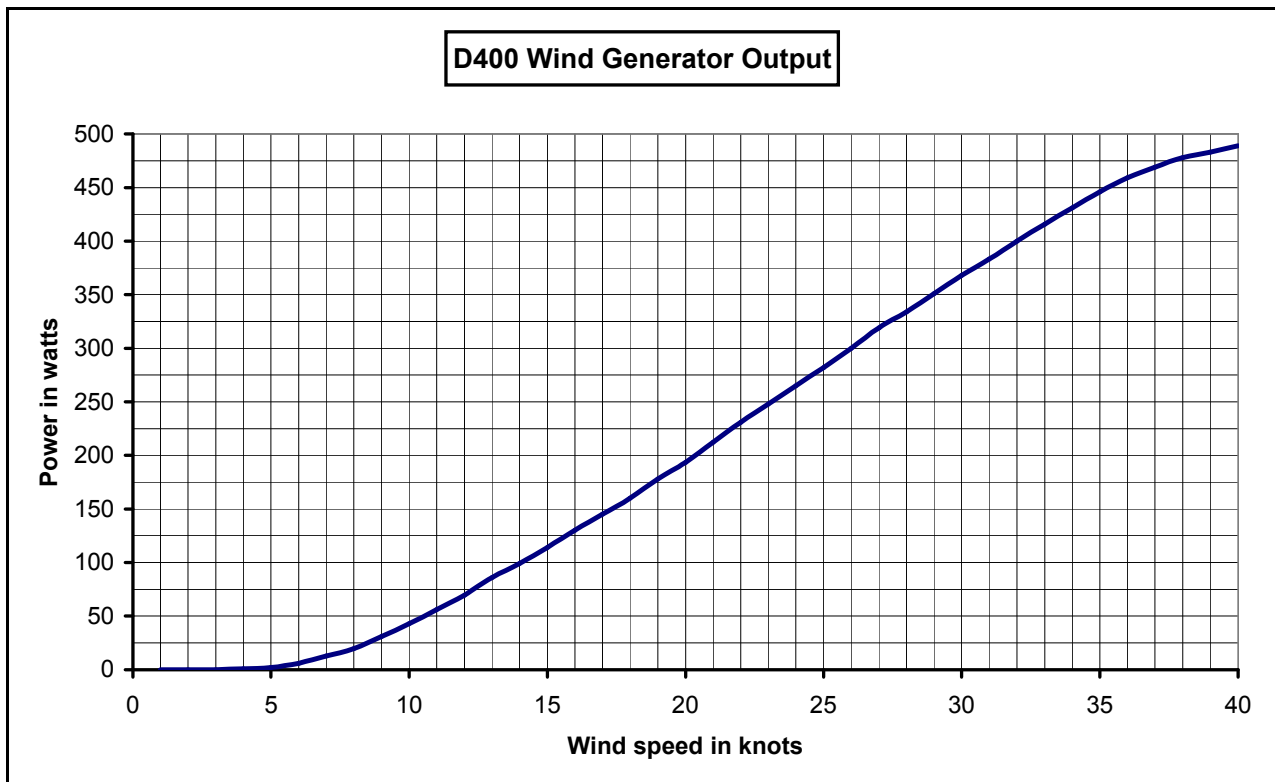

Checklist

Check that you have received in your delivery two cartons containing:

1 x alternator body
5 x air blades
1 x tail
2 x hub plates
1 x air hub spacer
Fasteners
1 x tower liner
1 x nose cone

Required for installation:

Mounting Tower
Extension cable
Batteries
Battery terminals
Connection blocks
Cable clips
Etc

Additional system items:

Regulator
Charge splitters
Volt and ammeters

Tools:

Spanners
Screwdriver
Wire strippers
Etc

The principles of Wind Energy

Wind is a function of solar energy unevenly heating the Earth's surface. As warmer air rises at the equator, cooler air flows in to replace it, setting in train global convective currents. This circulation which we call wind distributes both heat and moisture more evenly around the earth so providing us with a comfortable planet to inhabit.

The same process of convection also happens more locally, for example differential rates of heating and cooling between land and sea, producing the land and sea breezes which are most marked in the summer. These streams of moving air also provide us with an inexhaustible, if intermittent, energy source.

A wind generator works by converting some of the kinetic energy in wind stream to electricity. Air weighs about 1.2 kg per cubic metre at sea level, and kinetic energy is expressed by mass times the square of its velocity. Understanding this is a key to appreciating the energy available to wind generators.

In short, the amount of energy available to the wind generator rises dramatically with increasing wind speed. Regrettably, the reverse is also true. In low wind speeds there is very little energy to capture.

It is important, therefore, when considering the site of your wind turbine, that you choose a site with the highest possible wind speeds. In addition, the airflow should be as free from turbulence as possible.

Installation

Marine Mountings

When **mounting on a yacht or boat**, positioning the turbine will be influenced by the configuration of the boat and other equipment fitted. It is important to ensure that the blades are at sufficient height such that injury to the crew from rotating blades is unlikely. A minimum height of the lowest point of the airblades above a crewed area should be 2.4 metres.

Also ensure that no part of the turbine can come into contact with any other part of the boat's fittings or rigging. Because the turbine is subject to dynamic loads when the yacht is in a seaway in addition to wind loads, the tower should be securely braced or guyed both fore and aft and athwartships. The bracing struts or wires should be firmly attached to the main tower at a point 200 –300 mm below the lowest point of the blades.

The D400 is an inherently quiet and low vibration machine. However, certain applications may benefit from the introduction of anti-vibration mounts under the main tower and bracing struts. Note that, on a yacht or boat, no unsupported tower should exceed 2.5 metres in length. The wind loading on the D400's rotor disc can exceed 50 kg, so any tower structure should be designed to allow for a safe working lateral load of 70 kg at the hub height of the turbine.

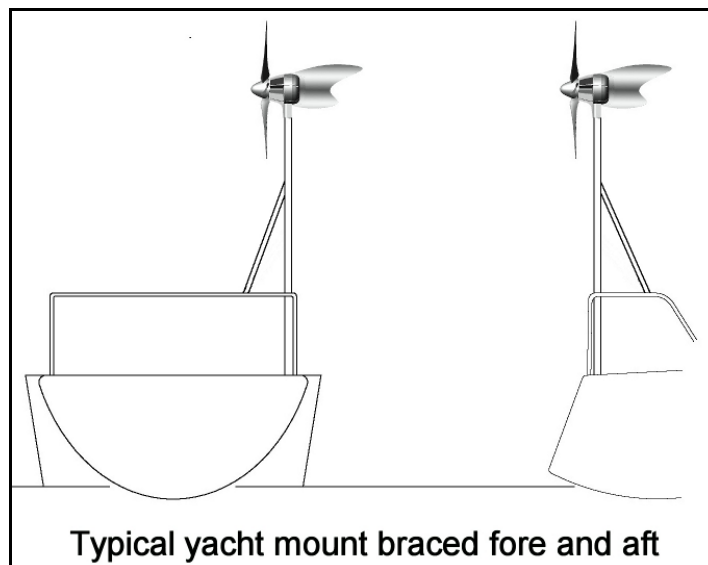

For inland watercraft such as narrow boats, a hinge-down tower arrangement can be utilised to allow for rapid lowering of the turbine for passage under low bridges etc.

For ketches and yawls, a mizzen mount is often suitable.

The D400 is also suitable for mounting on a stub tower from stern arches and targas.

Contact your Dealer or Eclectic Energy Limited for further information.

Terrestrial Mounting

The performance of your D400 will be influenced by the topography of your proposed mounting site. The golden rule with wind turbines is to mount them as high as is practically possible. The higher the turbine is mounted, the more productive it will be. This is because windspeeds reduce steadily as they approach the ground due to the effect of friction between the airstream and the earth's surface. This 'wind shear' effect is less marked over smooth surfaces such as the sea, and more marked over 'rough' surfaces such as woods or urban areas. Obstructions such as trees and buildings also introduce turbulence into the airflow, and no wind turbine works at its best in turbulent air. Given that low windspeeds and turbulent airflow will greatly reduce the efficiency of any wind turbine, it is important to locate the D400 in the clearest, fastest airflow possible.

Aim to mount your D400 at least 8 metres above the height of any surrounding obstruction within a 100 metre radius. If this is impractical, aim to mount the turbine as high as possible.

A useful assessment of the quality of airflow at a proposed location can be achieved by attaching a streamer, similar to a kite's tail, to a pole and letting it fly at the proposed height of the turbine. If the streamer flies straight, the airflow is clear. If the streamer flutters and spirals, turbulence is present, and you should consider an alternative site.

Mounting towers can be either guyed or free-standing. Free-standing towers need to be very substantial and require either a screw pile or concrete foundations. They are therefore generally expensive. Guyed towers are the more usual choice.

Guyed Towers

A typical guyed terrestrial mount for a D400 would consist of a tubular tower supported by four or more guy wires. No more than 2 metres of the tower should extend above the upper guy wire attachment point. The guy wires themselves should be of at least 4 mm in diameter with a breaking strain in excess of 50 kg. They should be galvanised or stainless steel for protection against the weather. Shackles and bottle screws should be at least 5 mm in diameter and where guy lines are looped, the loop should be held with a minimum of 3 wire rope grips, and should incorporate a thimble to form the eye.

Guy wire radiuses should be observed. The recommended radius for the guy wire anchors is 0.6 of the tower height.

Four guy wires are preferable to three, as this enables the tower to be hinged up from its base with three guy wires already in place to support the tower as it ascends.

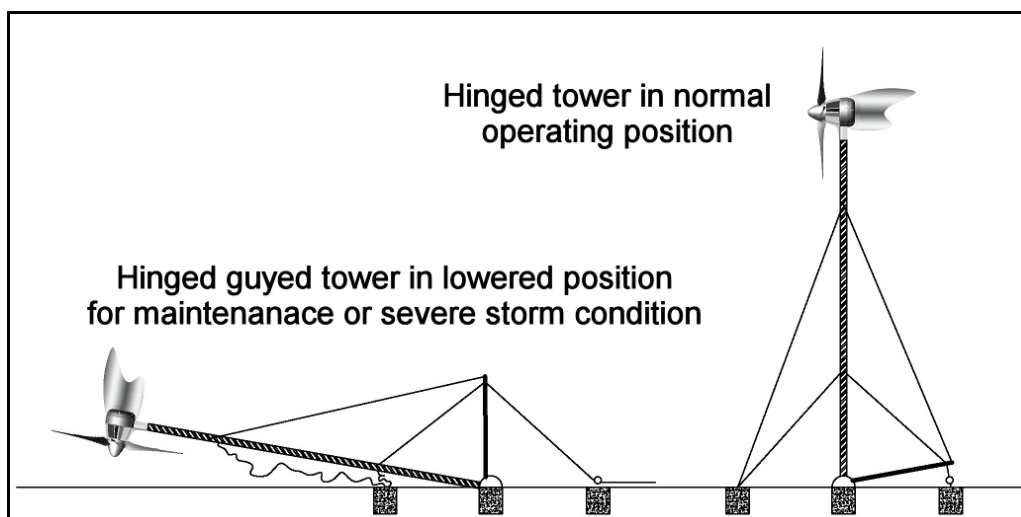

Correct use of Stub Tower

Minimum blade to tower clearance

130mm

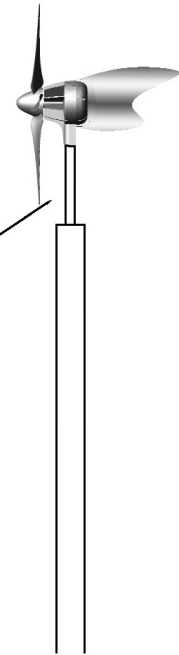

Freestanding Towers

For small wind turbines such as the D400, free-standing towers can take the form of old telegraph poles, or a self-supporting steel lattice tower.

It is important to ensure the tower's foundation is sufficient such that the tower will withstand a horizontal load of 70 kg at the height of the turbine.

In order to ensure that an acceptable blade to tower clearance is maintained, a stub tower should be used between the D400 and the free-standing tower. See illustration.



Roof Mounting

Due to its quiet, vibration-free operation, the D400 is particularly suitable for rooftop mounting.

Mounting on buildings has the advantage of achieving additional height. There is also often a localised increase in wind speed due to the compression effect of wind flowing over the ridge of the roof. This is particularly true when the prevailing wind is at 90 ° to the roofline. Generally speaking, a mount height of 1.5 to 2.5 metres above the ridge line will place the turbine in the best air flow.

It is important that the building structure and the mounting bracket attachment is sufficiently strong to support the turbine adequately in all wind conditions. Despite D400's quiet, low vibration operation, the installation may benefit from additional, anti-vibration mountings to prevent the transmission of vibration into the building structure.

Eclectic wall mount brackets, incorporating anti vibration elements, are available - contact your dealer or Eclectic Energy Ltd. for details.

Assembling the D400

Your D400 is supplied in two cartons. Unpack these and check the parts against the list at the beginning of this manual.

- Assemble the air rotor by sliding together the keys and mortises at the hub of the five air blades.
- Take the white, powder-coated hub plate, pass two 5mm bolts and washers through the inner holes, and fit the rotor hub spacer over the 5mm bolt heads.
- With the body of the wind generator on its back, offer the hub assembly up, and slide it onto the alternator shaft.
- Align holes in rotor spacer with 6mm tapped holes in alternator shaft and secure with two 6mm button head screws and shakeproof washers provided. Tighten firmly using a nut grade threadlocking compound to prevent the screws working loose in operation. * Take care not to overtighten these screws as this can cause the air rotor to run out of 'true'.
- An aluminium ring is provided to locate the blade roots securely. The ring is inserted, rounded side first, into the moulded annular recess on the rear of the blade roots.

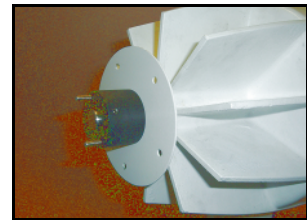
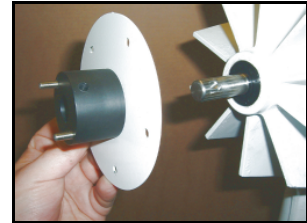

Offer rotor blade assembly up to rotor hub spacer and slide into place.

- Ensure that the rotor assembly is fitted the right way round. The annular groove on the blade roots should face the rear (tail end) of the machine, and the face with the 10 conical holes in the blade roots should face forwards.
- Fit outer stainless steel hub plate, place nuts and washers on inner 5mm bolts and tighten gently.

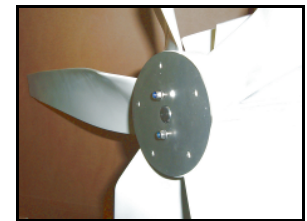

- Rotate air rotor in relation to hub until the five blade securing holes align.
- Pass a 5mm bolt through the inner powder-coated plate such that it passes right through the rotor blade and outer hub plate, fitting a washer and nut each time.



- Finally, evenly tighten all fasteners.
- Note that the rotor should only be secured using new nyloc nuts.*



Assembling the D400 (continued)

- Place the turbine face down on its rotor, and attach the tail using the three M6 nuts and bolts provided. Note that the tail should be fitted to the left-hand face of the casting flange when the D400 is viewed from the rear. The large stainless steel washers should also be fitted on the left-hand side.



- To fit the nose cone, offer up the axial splits in the moulding to the leading edges of the blades while holding the cone square and central over the hub. Gently open each of the axial splits, and encourage it to pass over the leading edge of the blades.

- Finally, rotate the nose cone anti-clockwise such that it effectively screws onto the blade roots. Snap the rear edge of the blades slot behind the trailing edge of the five blades (see pictures).

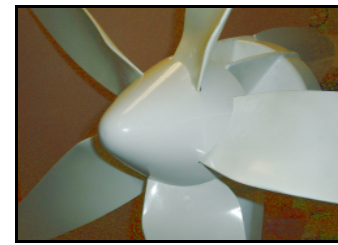

• Fitting D400 to the Tower

Remove the tower liner from the D400's yaw shaft, and check it for fit with the proposed mounting tower. It is far preferable to discover it does not fit at this juncture rather than when you are actually attempting installation. The standard tower liner has an outside diameter of 41.5 mm and is designed to slide into standard aluminium or steel scaffolding tubing with a nominal outside diameter of 48mm and inside diameter of 42 mm.

Should the tower liner not fit the tower tube correctly, consider sourcing an alternative mount tower or contact your supplier to order an alternative tower liner. On no account attempt an installation where the tower liner is a 'sloppy' fit in the tower, as this will lead to instability when the machine is operating, and could lead to machine damage.

- The tower liner is retained to the yaw shaft by three grub screws. Once the machine has been installed, the tower liner should be secured by drilling two holes through the top of the tower into the tower liner to a depth of 12mm with a 4mm drill, finally securing with two 8 x 12mm self-tapping screws.

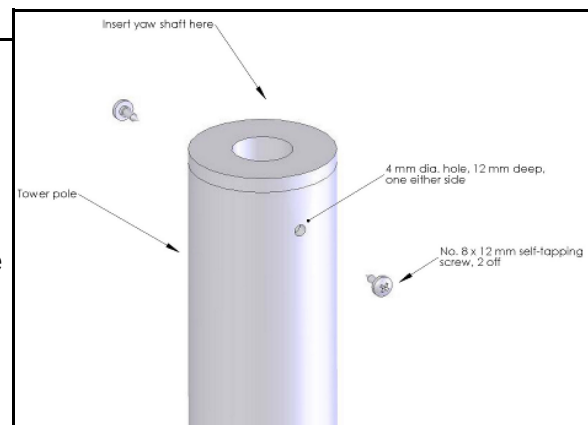

Your D400 is now ready for installation

Electrical Connections

Connecting cables between D400 and the battery bank or inverter should be appropriately sized to minimise transmission losses. For low voltage machines transmission losses are always a consideration, so it is advisable to keep cable runs as short as possible and be prepared to use heavier gauge cable for longer runs.

Suggested cable conductor cross-sectional areas for a 12V machine would be:

0 - 10 metres cable	6 - 8 ² mm
10 - 20 metres cable	10 - 16 ² mm
20 - 30 metres cable	20 - 25 ² mm

For a 24 volt machine, the transmission losses are lower. Suggested cable sizes would be:

0 - 10 metres cable	2 - 3 ² mm
10 - 20 metres cable	3 - 5 ² mm
20 - 30 metres cable	5 - 8 ² mm

Note, cable sizing is always a 'trade off' between the reduced electrical losses associated with using larger cable, and the additional costs and difficulty of the installation. The cable sizes recommended above will ensure acceptably high transmission efficiencies

Where D400 is fitted to a tall mounting tower, ensure the weight of the hanging cable is taken by a strain relief arrangement within the tower, rather than allowing all the weight to hang on the D400 cable connection.

Fusing:

D400 is capable of producing very high currents. A line fuse must always be installed in order to protect the D400. This is in addition to the fuses in the regulator output.

A blade-type 50 amp rated fuse and holder is supplied with 12 volt machines.

A blade-type 30 amp rated fuse and holder is supplied with 24 volt machines.

Note: This fuse should be installed between the turbine and the regulator and where a braking switch is fitted, the fuse should be installed between the switch and the turbine.

Regulation

Where D400 is being used for battery charging we strongly recommend that a regulator is installed as part of the system. The regulator's function is to prevent battery damage through overcharging. The regulator works by sensing battery terminal voltage and as a pre-set upper limit is approached, the regulator progressively dumps output from D400 to a pair of large, foil-wound resistors, where the surplus energy is lost as heat.

The 6TB regulator unit usually supplied with the D400 incorporates a charge splitter so its two outputs can be connected to two independent battery banks which will be charged simultaneously. The regulator will preferentially charge the lower of the two banks first.

Note: each output of the 12V regulator is protected by a 40 amp blade fuse. The outputs of the 24V regulator are protected by 20 amp fuses.

The regulator should be installed within 1 metre of the battery bank where possible and the dump resistors mounted horizontally in an area where air is free to pass over them for cooling.

See wiring diagrams on pages 13 and 14.

Stopping the D400

The D400 is a robust machine and can safely be left operating in most windspeeds. However, where extreme storm force winds are forecast, it is prudent to stop the machine and secure the rotor blades with a rope lashing.

The D400 can be stopped by gripping the tail and turning the machine out of the wind, securing the blades once they have stopped rotating.

Braking Switch:

A braking switch can be fitted which provides a convenient aid to stopping the D400. The switch should be a double throw 'break before make' type, rated at least at 40 amps. When operated, the switch disconnects the batteries from the D400 before short-circuiting the turbine.

The short circuit slows the rotor blades making it easier to turn the machine out of the wind and to secure the blades.

Please note: the D400 utilises a purpose-designed, highly efficient, axial field ironless alternator. This configuration delivers exceptional power outputs coupled with smooth, low friction running. These attributes are retained to some extent when the braking switch is applied, and in consequence the electro magnetic braking effect is not as marked as with other machines of more conventional alternator design.

In certain conditions, the rotor can overcome the braking effect altogether, which results in damagingly high currents being produced in the stator windings.

For this reason the braking switch should only be used to slow the unit prior to manually stopping it. It is not a parking switch. If the machine is left to run with the braking switch engaged, serious damage can occur to the generator.

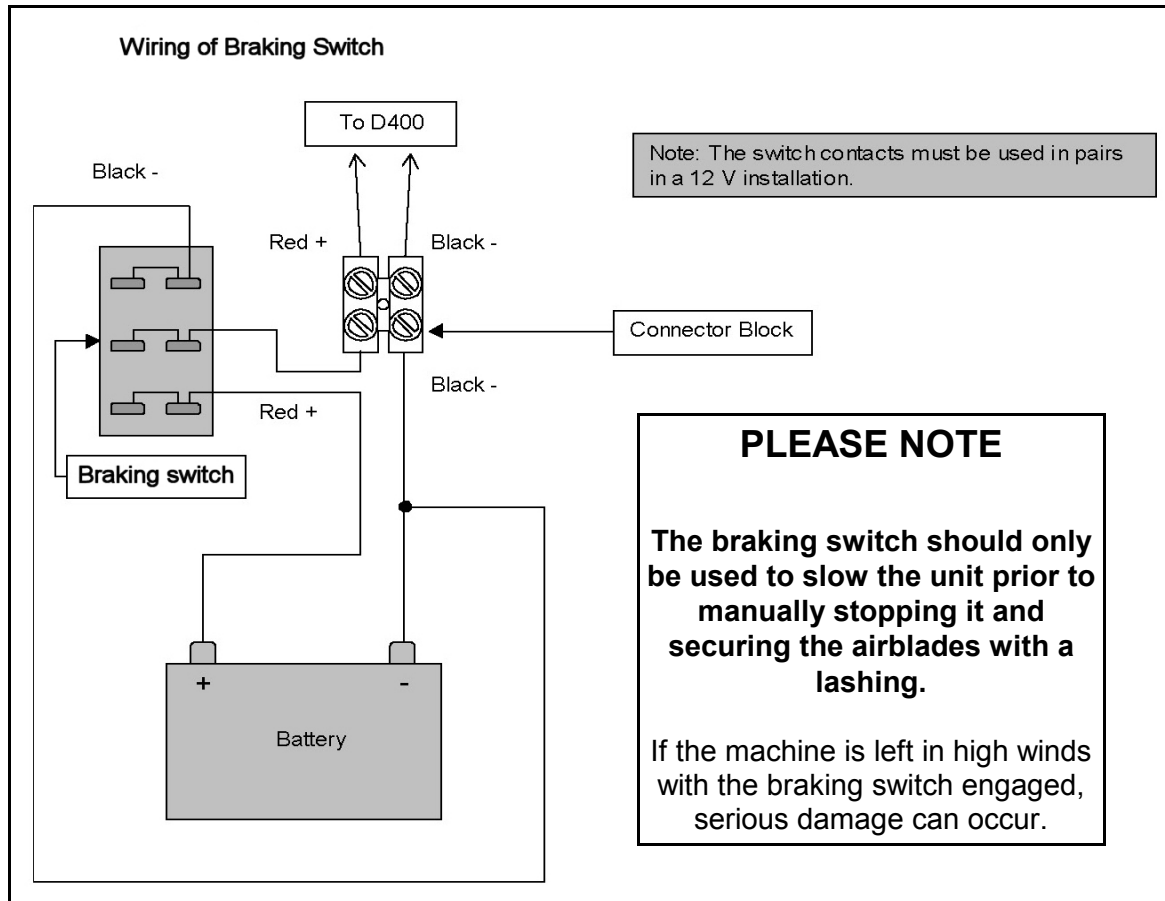

Electrical Installation

Single battery bank installation



It is recommended that the D400 is hard wired to the battery system.

In yacht installations, the cable should enter the yacht via a cable gland. Deck plugs and sockets should not be used as they represent a shock hazard if they accidentally become disconnected.

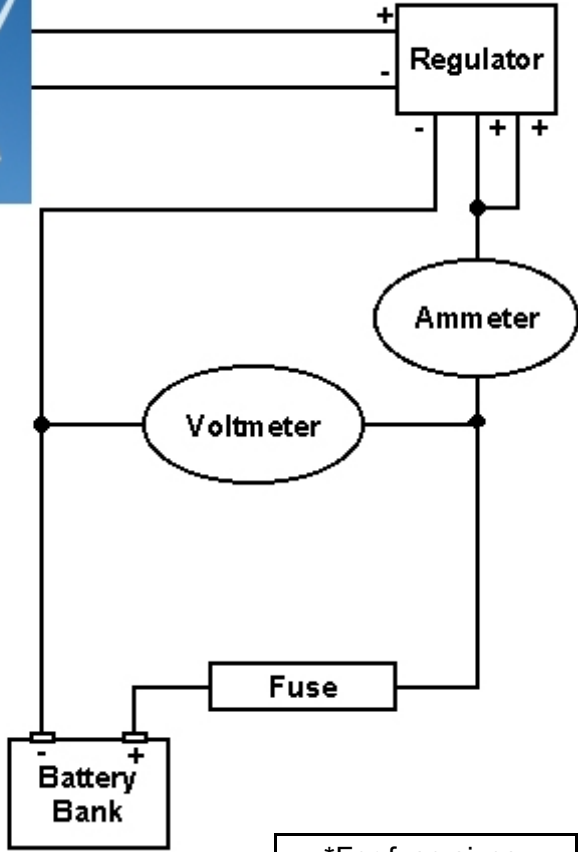

*For fuse sizes, see note on page 11.

The D400 should always be connected to a battery when in use, otherwise a dangerously high voltage can be generated at the output cable.



Unregulated installation

If in doubt, refer to a competent electrical engineer or the manufacturers.

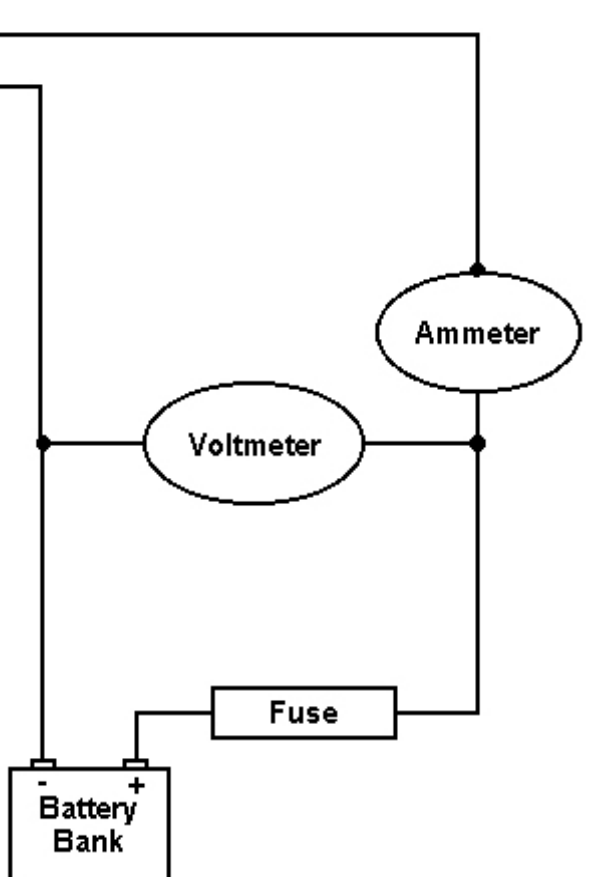

Electrical Installation

Connect the output cable to the battery bank(s) using the suggested wiring diagrams for guidance. Remember to observe the correct polarity.

RED to POSITIVE + and BLACK to NEGATIVE –

Twin Battery Bank Installation

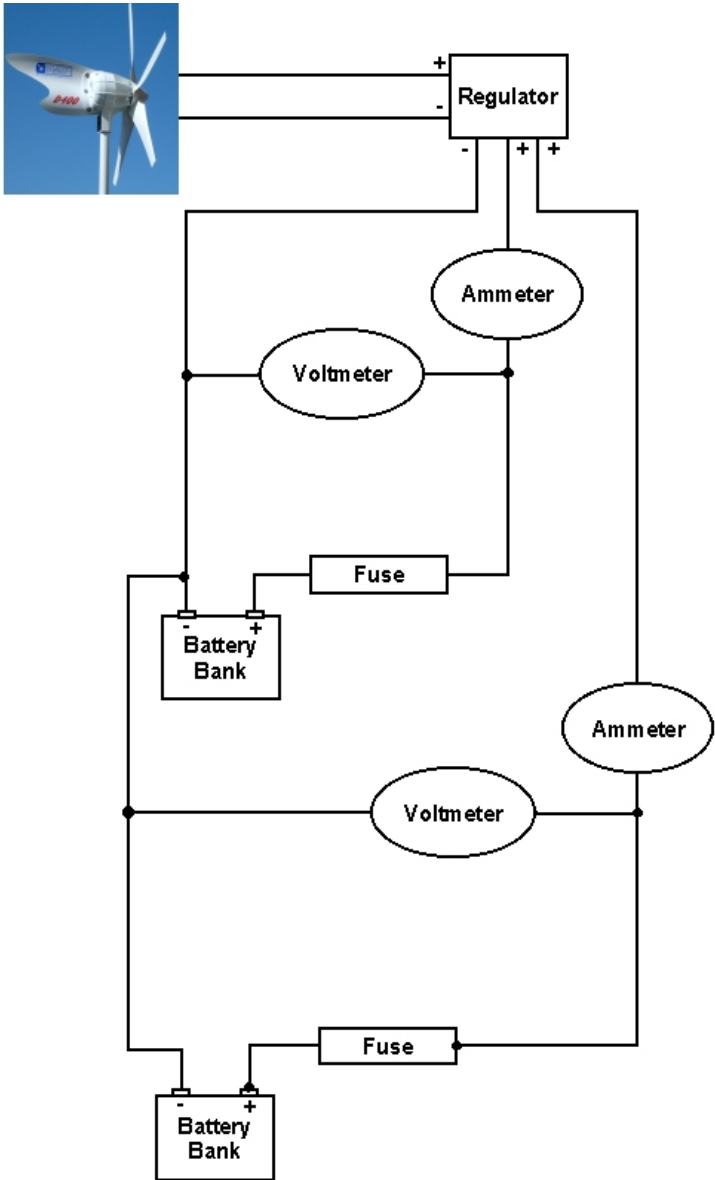

Where a battery monitor is fitted

If your electrical system is fitted with a digital battery monitor, it will be driven by a shunt which is typically installed close to the batteries.

One side of the shunt is connected directly to a battery terminal.

All other connections are made to the opposite side of the shunt, or a busbar associated with it.

The shunt is most usually connected in the negative line.

When wiring the D400 to a system fitted with a shunt, observe polarity and connect the appropriate D400 output cable to the non-battery side of the shunt.

Again observing polarity, the other D400 output cable should be made directly to the battery terminal.

The D400's output will now pass through the shunt and the battery monitor will display a reading.

If the shunt is bypassed by connecting both positive and negative output leads from the D400 directly to the battery, the meter will fail to 'see' the D400, and register no output.

*For fuse sizes, see note on page 11.

The D400 is fitted with 4.5 ²mm output fly leads
Refer to page 11 for suggested connection cable sizes

Performance and expectations

The D400 is extremely efficient by design, making it the most powerful and productive wind generator of its rotor size currently available.

The D400 should perform in line with, or exceed, the values given in the output graph. When verifying system performance, it is important that wind speed measurements are taken at the same height as the turbine, and that the batteries are at least 40% discharged.

Note also that if a regulator is installed as part of the system, dumped output will not be seen by shunt-sensed battery monitors.

Should outputs be well below expectations, first suspect turbulence in the wind stream. Turbulence at a given site can be specific to a particular wind direction where it is caused by an obstruction either up or downwind of the turbine. When the wind direction changes, and the obstruction is no longer in line with the turbine, outputs may return to expected levels. If the turbulent wind stream is not from the prevailing wind direction, this may not be important. Alternatively, the D400 could be re-sited or raised in height.

If poor output cannot be attributed to site conditions, re-check the whole installation against the wiring diagram and also look for poor or loose connections.

Check that the relevant connection from your D400 to the batteries is made to the non-battery side of the battery monitor shunt. If the connections are made direct to the battery terminals, bypassing the shunt, the ship's battery monitor will not be able to read the D400's output.

Note, where batteries are in a good state of charge, power diverted by the regulator to the dump resistors will not be seen by the battery monitor.

Finally, ensure that the battery bank is in good condition. Check individual battery terminal voltages within the bank. Defective cells within a battery bank are a common cause of poor charging performance.

Note that there is a short period of 'running in' with a new wind turbine. The bearings and shaft seals of a new machine take 40 – 50 hours of operation before mechanical friction falls to its design level. As a result, your D400 may seem a little slow to respond in light winds until this 'running in' period has passed.

Before deciding that your D400 is faulty, please work through the 'trouble shooting' guide on page 16. In our experience, 9 out of 10 problems reported prove to be faults in the installation rather than a problem with the turbine itself.

Please feel free to contact your dealer or Eclectic Energy Ltd. if you require additional advice or guidance.

D400 Trouble-shooting – Points to check if you think there's a problem

Mechanical checks:

- Spin the air blades by hand - they should rotate smoothly and freely with no hard spots.
- Listen for any grinding, scraping or rumbling noises - these would indicate failed bearings or contact between rotating parts inside the alternator.
- Note: if the air rotor rotates smoothly and silently, but feels stiff (like turning something in glue), refer to the electrical section on short circuits.
- Next, try rotating the D400 around its yaw axis. Again, it should turn smoothly and freely with no hard spots. If the yaw action is stiff or accompanied by undue noise, suspect the yaw bearings or the bush and slip ring assembly (see electrical section below).
- Check that the air blades are fitted the right way round, with the concave surface facing forward, i.e. towards the wind.
- Also, establish that the air hub is secure on the alternator shaft and that the air rotor does not 'wobble' due to wear at the hub.
- Finally, check that all fasteners are tight and secure.

Electrical checks:

Very often poor turbine performance is traced to a problem elsewhere in the installation rather than a fault with the wind generator itself.

- First check that both the D400 and the regulator are the correct voltage for the electrical system. Both items have identification labels showing the voltage, typically 12 or 24 volt.
- The most common cause of low outputs are loose or corroded connections in the output cabling. Check and re-make all connections from turbine to battery. Seawater and electricity are not a good combination, and connections deteriorate very quickly when wet.
- Next, check the turbine by measuring its open circuit voltage. Disconnect the unit as close to the turbine as possible. If it is not too difficult, remove the turbine from its tower and measure at the fly lead cables exiting the yaw shaft of the machine itself.
- With a multi-meter set to the 20 volt DC range, connect the red positive meter lead to the red output, the black meter lead to the black output, and spin the unit by hand. On a 12V D400, you should be able to produce 4, 5 or even 6 volts, depending on how hard you spin. If you see voltages in this range, then the D400 is probably OK. If the D400 has an internal fault such as a missing phase in its alternator, then you will not be able to produce more than one or two volts.
- Assuming the output voltage is OK, try rotating the yaw shaft (where the cables exit) whilst continuing to spin the rotor. If the voltage varies or disappears as you rotate the yaw shaft, the brushes and slip rings require cleaning. Equally, if the voltage remains steady, but the yaw shaft is unduly stiff or squeaks when rotated, the brushes and slip rings would benefit from cleaning.
- If the turbine checks out OK on the voltage test, suspect the rest of the installation. Check each wiring connection for corrosion, tightness and security as well as the fuses, fuse holders etc.
- If a regulator bypass switch is incorporated within the installation, check that this is wired in accordance with the diagram contained in the D400 regulator instructions. Note that a similar switch can be used as a braking switch, and the wiring for this is shown on page 12 of the D400 User's Manual. Ensure that the two options have not been confused.
- Note that the ship's battery monitor is driven by a shunt, which will be mounted close to the batteries. Ensure the D400 is connected to the non-battery side of the shunt. If it is not, then the D400 output will not be seen by the meter.
- Also, the D400 regulator incorporates a charge splitter (i.e has two outputs). If one of these is connected to the service battery bank and one to the cranking battery or windlass battery, it is possible that power from the D400 is flowing to them in preference to the service bank. Try connecting both regulator positive outputs together and on to the service bank to see if that improves matters.
- Finally, put a dedicated ammeter in the positive line between turbine and regulator. This should read all current from the D400, including any diverted to the regulator dump loads.

Trouble-shooting continued - Poor Yaw Action:

- Stiffness in yaw; the D400 will not rotate to face the wind
 - check for any physical obstructions and the action of the yaw shaft. If the yaw shaft does not rotate freely, suspect damaged or corroded yaw bearings, damaged or corroded slip rings/brush assembly or possibly a bent yaw shaft.
- Erratic yaw action; the D400 turns off the wind and is unstable
 - the D400 is normally very stable in yaw. If the turbine appears to ‘hunt around’ its axis, this could be due to turbulence in the airflow. If so, the problem should disappear when the wind changes direction or the yacht is in a different location. Check that the D400 is properly secured to the mount tower. There should be no undue play between the turbine and the tower. Also, ensure that the tower is vertical and sufficiently rigid. If the tower is too flexible and bends excessively under wind loading, it should be braced or guyed to stiffen it.
- Open Circuit; this is a major cause of poor yaw action, indicating that the turbine is not properly connected to the batteries.
 - in this open circuit condition, the air rotor will over speed and the air blades will become uncharacteristically noisy, emitting a whistling noise. The D400 will frequently turn off the wind, rotating through 360 ° on occasion. Check all wiring, looking for poor or broken connections. Also check fuses. If the fault remains, bypass the regulator to rule out regulator malfunction as the cause of the problem.
- Intermittent or occasional erratic yaw action
 - this could be due to an intermittent electrical fault. If you observe turbine output abruptly dropping out and then suddenly returning, this could indicate a poor connection between the brushes and slip rings.
To service, remove the four self-tapping screws that secure the black brush-holder plate. Remove the brush-holder plate, taking care not to displace the brushes or brush springs.
The slip rings and contact faces of the brushes can then be cleaned with a solvent-soaked cloth or fine, wet and dry paper.
- Squeaking or grating noises audible in yaw
 - this could be caused by damaged yaw bearings. More typically, it is caused by dirt or corrosion on the slip rings/ brushes.
Remove the brush-plate as above. If noise is still present with the brush-plate clear of the housing, suspect yaw bearings. If the squeak has gone, it confirms the noise emanates from the brush and slip ring assembly. Clean these parts as in the last section. Also, using a fine file, remove any sharp edges from the contact surfaces of the brushes.
On re-assembly, the yaw shaft should rotate silently. If a squeak is still evident, remove the brush plate again and spray the slip rings and brushes with an electrical lubricant (WD40 or similar) or smear a little silver-loaded grease on the slip rings.

Undue mechanically transmitted noise or vibration

- *Noise or vibration transmitted down the shaft*
 - suspect a loose air rotor. Grasp an air blade and rock the rotor to check if there is any relative movement between the air rotor and the alternator shaft. If play is felt, remove hub parts and re-build, fitting a new hub liner.
- *Correct fit of nose cone*
 - check that the nose cone is not catching on the alternator housing.
- *Air blade damage*
 - check that the blades are not damaged or chipped. This may put the rotor out of balance. Replace air blades as necessary.
- *Tail bolts*
 - check tail bolts are tight.
- *Noises from the alternator*
 - rotate the air blades slowly and listen at the alternator housing. Grating or scraping noises indicate a fault within the alternator.
Refer to your dealer or Eclectic Energy Limited.

Routine Maintenance

The D400 is robustly engineered and should give years of trouble-free service.

Bearing life in normal windspeed conditions is expected to be in excess of 10 years. Shaft seals may benefit from replacement after five years.

The yaw bearing brushes should not require replacement during the life of the machine.

The alternator itself is hermetically sealed against moisture ingress.

Routine maintenance would consist of periodically examining the air blades for signs of damage. Blades exhibiting chips or nicks should be replaced.



www.eclectic-energy.co.uk



DECLARATION OF CONFORMITY

We declare that this product complies with the following standards/directives:
89/336/EEC

Product description: D400 Alternator

Model number: EE400

Serial number:

Signed:

Peter J. Anderson

Eclectic Energy Limited

Edwinstowe House

High Street

Edwinstowe

Nottinghamshire

United Kingdom

NG21 9PR

+44 (0) 1623 821535

GUARANTEE

The D400 Wind Generator is guaranteed against faulty parts and manufacture for a period of two years from date of purchase.

The unit should be returned prepaid to:

Eclectic Energy Ltd Edwinstowe House High Street Edwinstowe
Nottinghamshire United Kingdom NG21 9PR

Damage caused by mishandling, faulty installation or accident is not covered. Eclectic Energy can not be liable for damage caused by the D400 in the event of accidental contact, incorrect installation or insufficient care.

However, Eclectic Energy Limited is committed to provide after sales care as fully and efficiently as possible in order to support our customers.

This guarantee does not affect your statutory rights.

D400 Specifications

Output	Rated Power (W)	225 @ 11 m/s (22 knots)
		400 @16 m/s (30 knots)
	Max. power (W)	500 +
	Rated Wind Speed (m/s)	16.5
	Rated rotational speed (RPM)	1200 @ 16 m/s
	Cut-in wind speed (m/s)	2.6 (5 knots)
	Cut-out wind speed	none
Turbine	Turbine type	Horizontal upwind
	Number of blades	5
	Airfoil type	Low Reynolds - variable camber
	Diameter of turbine (m.)	1.1
	Swept area (sq. m.)	0.95
	Tip speed ratio	4
	Typical noise level	2 - 6 dbA over background
	Material	Glass-filled nylon
Alternator	Design	Direct Drive
		12 pole PMG
		3-phase AC
		Output DC
		High energy ferrite magnets
		Encapsulated stator
	Voltages available	12, 24, 48, 72 DC
		240V AC Grid connect via inverter
	Materials	Alloy housing, hermetically sealed
		Alachrome and polyester powder coat
		316 S/S shafts
EMI (electromagnetic emissions)	C.E. compliant	
Control system	Stall regulation	
Brake system	Braking Switch	
Yaw System	Passive	Low resonance, formed aluminium tail
		Slip ring assembly with saddle spring
		loaded output brushes
Mounting	Stub tower	50mm O/D - 42mm I/D
Weight	Total	17 kg.
Finish	Colours available	White with white blades
		Black with translucent blades

Estimated Annual generation (AEP) for D400/ StealthGen

